

KADZAMA

TECHNOLOGY FOR SUCCESS

Painting Spray Cabin

Manual



The present user manual is intended for studying the design, key technical characteristics, operating principles, and rules for the technical operation of a Painting Spray Cabin for chocolate products.

Before starting operation, carefully study this manual!

Improper use of the equipment may pose a safety hazard. Beginning to use the device signifies that you have fully read the manual and understood the operating rules.

KADZAMA company thanks you for purchasing its equipment and wishes you an enjoyable working experience.

1 — Purpose of the device

The "Painting Spray Cabin for Chocolate Products" is designed for the even application of colorants to chocolate products, ensuring high-quality coating and minimizing material waste.

2 — Specifications

Overall dimensions (LxWxH)	850 x 500 x 975 mm
Weight	40 kg
Power supply	220 V / 50 Hz
Power consumption	0,35 kW
Noise level (max.), [dB]:	60
Overall dimensions in the package	950 x 600 x 1075 mm
Package weight	45 kg

3 — Configuration

Painting Spray Cabin for Chocolate Products – 1 unit

Bracket for the Spray Gun – 1 unit

User Manual – 1 unit

Warranty Certificate – 1 unit

4 — Safety measures

4.1 The Painting Spray Cabin for Chocolate Products is an electrical device with a certain level of potential hazard.

4.2 When connecting the device to the electrical network, follow all necessary precautions to avoid electric shock.

4.3 The Painting Spray Cabin should be connected to the network and operated only by trained personnel.

The device must not be operated without electrical grounding (wire “E” for Euro plugs).

4.4 Operate the device only for its intended purpose.

4.5 Operate and store the device in places inaccessible to children.

4.6 Do not leave the device turned on for extended periods without supervision.

4.7 Do not operate the device with wet hands.

4.8 Do not operate the device when the ambient air temperature is below 10°C or above 40°C, and the relative air humidity is over 80%.

4.9 If the device has been transported at sub-zero temperatures, it must be kept at room temperature for at least 1 hour before being turned on for the first time.

4.10 Any maintenance or care actions should be performed only when the power cord is unplugged from the network.

4.11 Repairs or disassembly of the device may only be carried out by a qualified KADZAMA specialist.

5 — Constructive elements description

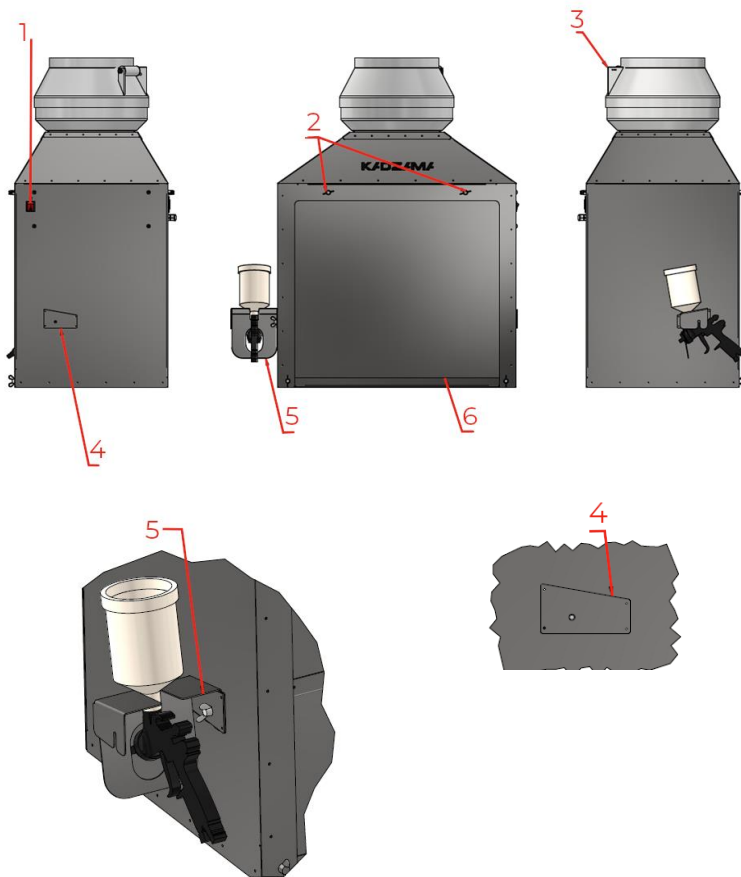

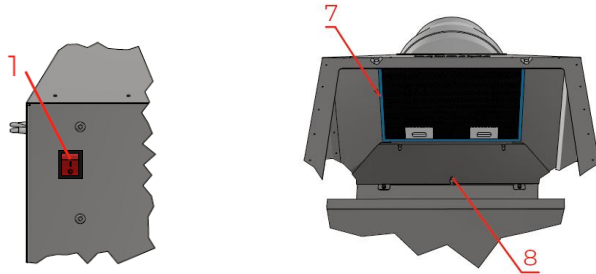

-
- | | |
|---|---|
| 1 | ON/OFF Button |
| 2 | Thumb Screws for Lamp Holder Attachment |
| 3 | Exhaust Fan |
| 4 | Right Slot for Bracket Installation |
| 5 | Spray Gun Bracket |
| 6 | Scraper Bar for Cleaning the Spatula |
| 7 | Filter |
| 8 | Protective Glasses |
-

6 — Before start

6.1 Remove the packaging.

6.2 Place the melting tank on a flat, solid surface, ensuring easy access to the controls.

6.3 Ensure that the distance from the sides of the unit to the nearest objects and walls is at least 10 cm, and that the ventilation openings are not obstructed.

6.4 Install the fan in the cabin window.

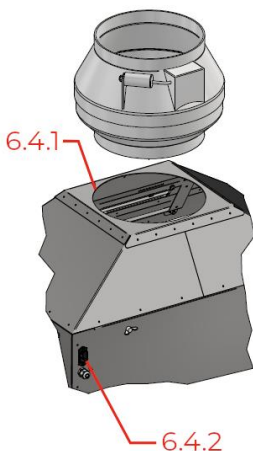

6.4.1 Install the fan in the cabin window.

6.4.2 Connect the fan's electrical cable to the power plug.

6.1 Установите жировой фильтр.

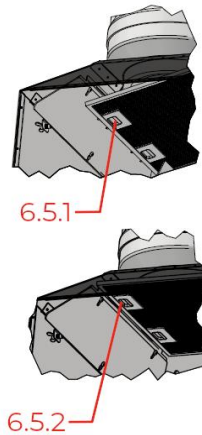

6.5.1 Press the filter lock buttons.

6.5.2 Snap the filter into the grooves of the holder.

6.6 Plug the power cable into a 220V outlet.

7 — Exploitation

7.1 Start the device using the ON/OFF button.

7.2 Place the chocolate products on the rotating platform inside the cabin.

7.3 Activate the spray system by selecting the desired mode using the controls on the spray gun.

7.4 After finishing, turn off the spray system.

7.5 Disconnect the cabin from the power supply.

7.6 Clean the internal surfaces of the cabin and replace the filters if necessary. Cleaning should be done at the end of each work shift.

8 — Maintenance and care

8.1 Keep the device clean during operation.

8.2 It is permissible to wipe the body with a damp cloth, but first disconnect the cabin from the power supply.

8.3 To clean the internal surfaces of the cabin, open the lid and use mild cleaning agents.

8.4 Do not allow water to come into contact with the electrical components of the cabin.

8.5 Unscrew the screws, remove the scraper bar, and wash it with hot water.

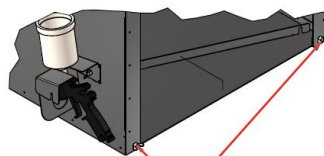
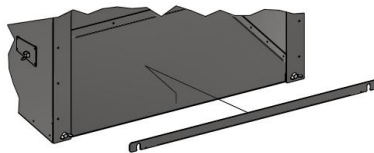

8.5.1

8.5.1 Insert the scraper bar into the cabin and secure it with screws.

8.6 Unscrew the screw, remove the bracket, and wash it with hot water.

8.7 After cleaning, insert the protective glasses into the cabin. Align the grooves of the glass with the screws and slide them down.

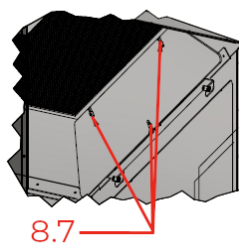
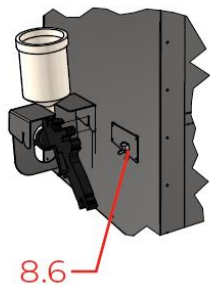

9 — Warranty

9.1 The warranty period (as well as the terms of warranty service) are specified in the warranty certificate.

kadzama.com

sales@kadzama.com

Meets certification requirements

CE EAC